

Panasonic
ideas for life

BIG DISPLAYS FOR BIG BUSINESS

panasonic.net/proplasma

85"/103"

1080p Full HD Professional Plasma Displays

Panasonic
ideas for life



Control 

Simulated pictures on screen.
Specifications are subject to change without notice. Printed in Japan
CT103/85FHD-G01

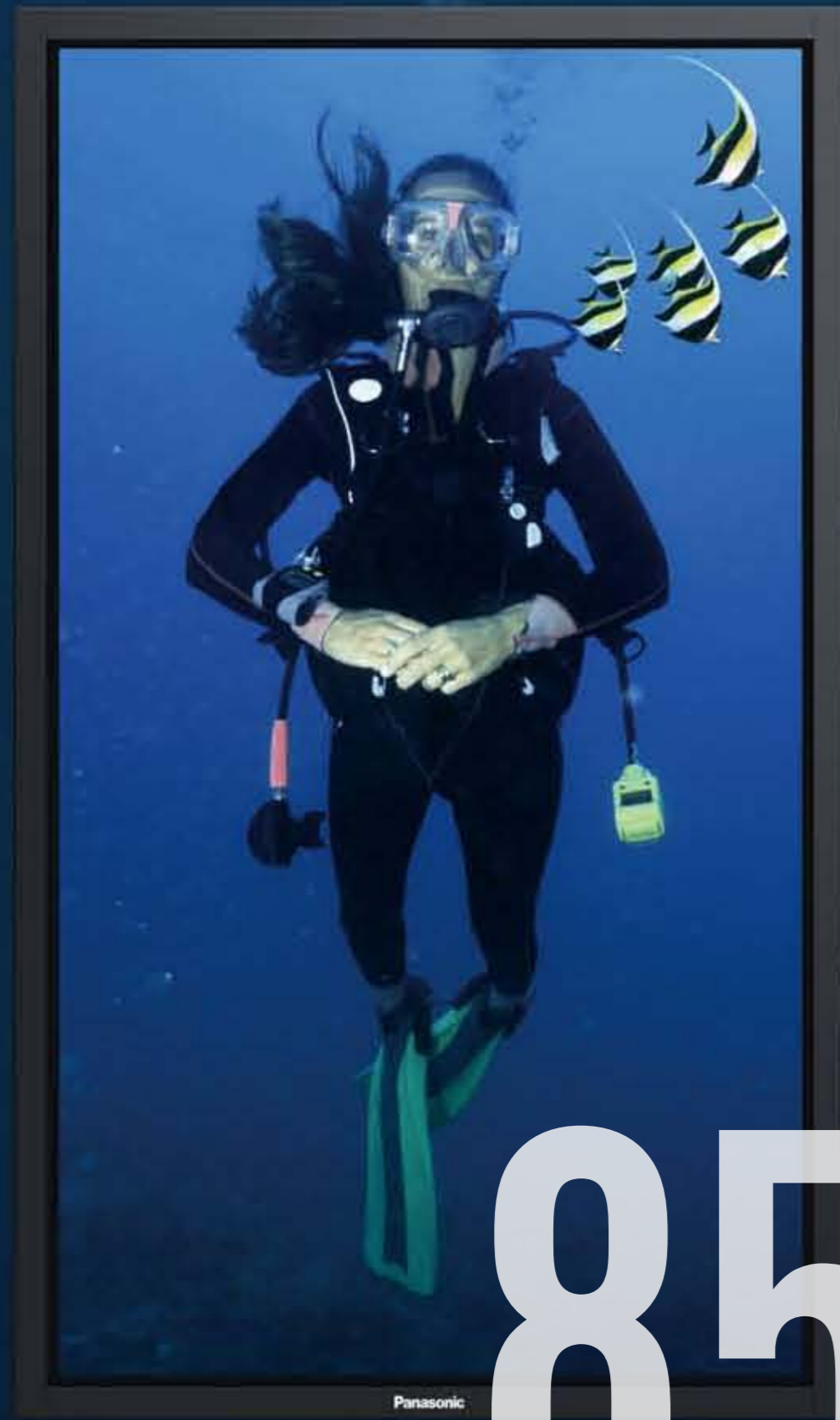

Displays realistic,
life-size images of people.

85 inches



Creates breathtaking scenes with incredible depth
for large viewing spaces.

103 inches

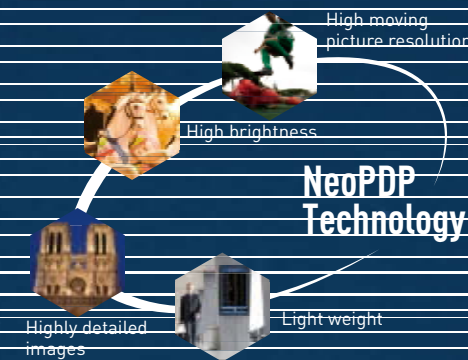

The Outstanding Images and Large Screens of Professional Plasma Displays Provide Advanced Business Solutions.

NeoPDP technology, which we developed by integrating years of accumulated plasma technologies, has doubled the luminous efficiency* of our displays. Display panels featuring this new technology offer remarkably improved brightness, 40,000:1** contrast, and enhanced motion image performance. From dazzling whites to deep, robust blacks, they portray a wide palette of colours with rich gradation. Even the tiniest details in fast-action images are reproduced with crisp clarity thanks to 1,080 lines** of moving picture resolution, achieving a level of quality that is possible only with a high-definition display. And panel depth and weights have both been reduced.

*Comparing full-HD models in existing sizes with same-size 2007 Panasonic models.
**Back-contrast that can be displayed simultaneously on the same screen.
1: Back-contrast measurement of detail in displayed motion pictures (discernible by the human eye).
2: Moving picture resolution is a quantitative measurement of detail in displayed motion pictures (discernible by the human eye). Using a measurement method developed and applied by the APDC (Advanced PDP Development Centre Corporation).

Tough Displays with a Front Panel of Hard Glass

Hard glass protects the front surface of the displays. In the case of an external impact, this durable design will help to prevent cracking and other damage.

Products That Help the Environment



These plasma display panels offer a long life of approximately 100,000 hours.** Regardless of whether you use them vertically or horizontally, you get years and years of sharp, beautiful images. Panasonic also led the industry in developing and mass producing lead-free plasma display panels. Our entire line of plasma display panels became lead-free in 2006, to minimize the possibility of polluting the environment with harmful substances following product disposal.

**Guideline operating hours before the panel brightness is reduced to half when the panel is used to display motion pictures in the standard mode. After images (burned-in images) and malfunctions are not taken into consideration.

Presentations

Share Information with More People

Large-screen plasma displays provide powerfully persuasive presentations by accurately conveying information to all viewers. The wide viewing angle ensures a clear view from anywhere in the room, and superb full-HD images bring remarkable impact to large-screen presentations. Together, they help everyone to understand and share information.

Get Your Information Across with a Large Screen

Sharp images and bright colours allow these large-screen displays to grab and hold your viewers' attention. The wide viewing angle makes sure that everyone will have a clear view regardless of where they sit, making it easier to share information and ideas.



Ideal Displays for Small and Medium Size Rooms

You don't need a large conference room to use a large-screen display. To accurately convey your presentations, you simply need large, easy-to-read text and a viewing distance that allows people to see the screen clearly even from the back of the room. These Panasonic displays ensure high visibility in conference rooms seating anywhere from a dozen people, and they fit perfectly in small spaces thanks to their slim, compact designs.

On-Screen Text Displays

42(50)-inch Models 85(103)-inch Models



Comparing the materials shown on the display, the text on the screen is double the size. The 18-point font that is commonly used for TV conferences can be read clearly even from the furthest edges of the conference room.



Because the screen brightness can be adjusted to match the content, images can be displayed even in ordinary conference room lighting without tiring the eyes.

Installation Examples

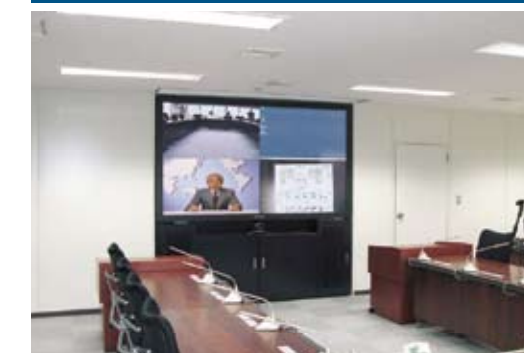

Tokyo Metro Co., Ltd.
Tokyo, Japan

This conference system, centring on a 103-inch plasma display, has been installed at the company's Response Headquarters. It supports accurate, swift decision-making in the event of a natural disaster.



Kokushikan University
Tokyo, Japan

This 103-inch display was installed in the AV hall of the university library to allow accurate, clear reproduction of academic materials. In addition to supporting study and research activities, the display greatly improves the quality of lectures and motivates overall learning.



National University of Singapore
Singapore

The projector system previously used in the lecture room was replaced with this 103-inch plasma display. It resolved a number of problems, such as images being difficult to see unless the room was darkened, and the lecturer's shadow blocking the screen.

[Lifelike Ambience]

A large screen enables true-to-life TV conferences that make it feel like everyone is in the same room. This makes it easy to catch and understand even nuanced expressions and reactions.



[Network Functions]

A LAN connection lets you operate the display by remote control. Compatibility with the industry-wide PJLink™ standard allows efficient operation with existing infrastructure.

Network Diagram

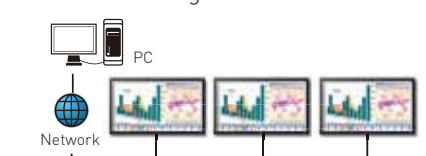

The display can be remote controlled and operating parameters such as the input signal can be checked over the network for greater convenience.

*Applications have been filed for the trademark rights to PJLINK in Japan, the USA, and other countries and regions.

[Flexible Installation]

Neat Wall Mounting

With a projector, you need to set up and store the screen every time you use it. With a wall-mounted plasma, there is no such hassle. Just switch on the power.

Flexible Floor Installation

Using an optional floor stand for the 85-inch model lets you install it anywhere, without requiring any wall reinforcement or other mounting work.



Digital Signage

Experience the Appeal of Large-Screen Power

Dynamic large-screen images seem to jump out at people passing by. In addition to displaying tiny details, large-screen displays mesmerize viewers with their true-to-life expression. In short, their images look like the real thing. They also display powerful videos and bright digital posters for all kinds of business promotions.

Eye-Catching Large-Screen Effects

The 220-cm (approx.) length of the 103-inch display provides much of its incredible impact. And the 85-inch display can project life-size images of people when it is installed vertically. Both of these large screens feature the kind of high resolution that can only be produced with the excellent moving picture resolution of the plasma system. Their clear, high-definition images produce superb eye-catching effects.



A Brighter Screen with NeoPDP Technology

The NeoPDP technology employed in these models has doubled*1 luminous efficiency as compared with our 2007 models. In addition to higher screen brightness, this technology also boosts the level of expression to enhance the display's eye-catching appeal. And it minimizes power consumption to reduce running costs.



*1 Comparing full-HD models in existing sizes with same-size 2007 Panasonic models.

[Excellent Colour Reproduction]

A wide colour gamut that exceeds the HDTV standard* for high-definition broadcasts faithfully reproduces the original image colours and textures. The wide viewing angle also reliably and beautifully conveys the images even in large spaces where people pass by in various directions.

*Standard: ITU-R BT.709

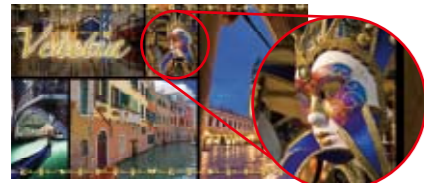

Subtle colour shades and detailed textures are realistically displayed. These large, high-impact screens create impressive signage systems.

[Durability]

Impact-resistant hard glass protects the front of the plasma display. This makes it possible to install displays in public spaces and inside stores, where people may touch it, without worrying about it being damaged.

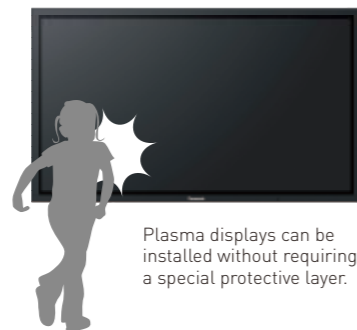

Plasma displays can be installed without requiring a special protective layer.

[Flexible Installation]

Neat and clean layouts that don't block traffic paths are created by suspending the display from the ceiling or mounting it to a wall. The plasma display's wide viewing angle also ensures that everyone will have a clear view wherever it is installed.



Unlike an ordinary poster, you don't need to replace the display to change the content. This powerful, moving signage provides crisp, clear information and has a tremendous promotional effect.

Installation Examples



MEDIAPRO

Barcelona, Spain

MEDIAPRO's newly built Production Centre in Barcelona is the proud owner of the world's largest plasma display video wall. Nine Panasonic 103-inch full-HD displays have been installed in a 3 x 3 matrix in the reception area of their new offices. Visitors are captivated by dynamic moving images promoting the company's activities.



Flora Shopping Centre

Prague, Czech Republic

Three 103-inch plasma displays are suspended from the ceiling in a vaulted area of this shopping centre. The digital signage presents clear information to each floor, giving customers a dynamic form of advertising that simply isn't possible with ordinary posters.

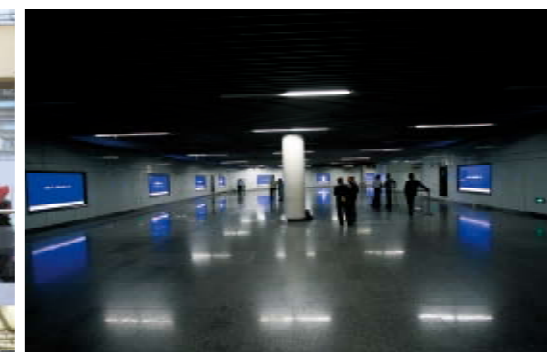

Shanghai Metro People's Square Station

Shanghai, China

Digital signage with ten plasma displays is installed at this subway transfer station, which is used by more than 500,000 people a day. Compared to conventional illuminated signboards, these displays have a more powerful advertising effect due to their ability to display fast-moving images. They communicate advertising messages more effectively because they attract more attention.

TV Stations/Video Production

High-Impact, High-Quality Large-Screen Images

Panasonic plasma displays faithfully reproduce all kinds of images, from still shots to video clips. Their high contrast and moving picture resolution provide clear and accurate views of everything from flip charts to live relays. And an optional terminal board adds HD-SDI interface support. All of this makes them ideal for broadcasting use, where optimal image quality is essential.

In TV studios...

Large-Screen Displays with a Slim Profile

Wall mounting enables a neat, clean layout even in small studios. The slim design of the 85-inch model has a depth of only 99 mm. Large-screen displays give the room an impressive ambience while producing highly detailed images and offer a stylish match to studio interiors.



Compared to conventional types that require considerable depth, slim plasma displays can be installed in small spaces.

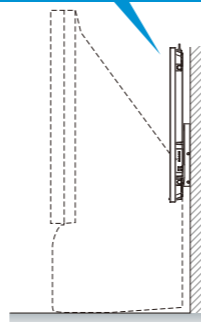

In editing rooms...

Faithful Colour Reproduction

The 103-inch model is equivalent to four 50-inch screens, and the 85-inch model is equivalent to four 42-inch screens. When displaying multiple image sources, original image colours can be faithfully expressed without being affected by the contrast and colour of adjacent images.



103-inch (85-inch)

* An external screen splitter is required.



50-inch (42-inch) x 4

HD-SDI System Compatibility

Both displays are compatible with high-resolution, image-enhancing Dual Link HD-SDI (SMPTE372M compliant) and HD-SDI (SMPTE292M compliant) interfaces. They are capable of reproducing the outstanding, full digital image and sound transmission that is used by broadcasting stations.

< Optional Function Boards >

Dual Link HD-SDI Terminal Board with Audio TY-FB11DHD



- High quality and high definition interface terminal board
- Supports Dual Link HD-SDI (meets SMPTE372M standard), and HD-SDI (meets SMPTE292M standard)
- Supports DCI 2K (RGB4:4:4/YPbPr 4:2:2 at 60p, 50p) without image resolution conversion.
- Supports SMPTE audio (16 channels) (this is only when the signal is multiplied to Dual Link HD-SDI Link: A)

* DCI refers to Digital Cinema Initiatives.

HD-SDI Terminal Board with Audio TY-FB10HD



- Enables viewing of digital high definition images from digital video equipment on a plasma display, using a terminal board compatible with the SDI system used by facilities such as broadcasting stations.
- Provides simultaneous video and audio signal transmission (16 channels) using a single cable.



Installation Examples



TV Tokyo Corporation Tokyo, Japan

TV Tokyo installed a 103-inch display on the studio set of its news program in order to display images in full-HD quality. In spite of the impressive presence of the huge screen, its compact body gives the set design a neat and clean appearance.



Channel Nine Australia

A plasma display is used for a popular talk show called the "footy show." It presents fast-action sports scenes in high resolution, and greatly enhances the video images that are displayed throughout the show.



Czech TV Czech Republic

A 103-inch plasma display was installed in the studio of the "Good Morning Show." The large-screen display is situated behind the newscasters, and its stunning images have become a highly distinguishing feature of the show.

Amusement Facilities

Vividly Colourful Spaces Created by Large-Screen Displays

These high-quality, large-screen displays are minimally affected by even the brightest surrounding illumination. Also, mood boosting images have a much greater effect when shown on a large-screen display. When multiple images of detailed information are displayed on a large screen, they all appear bright and clear. This allows the display to show several types of information simultaneously.

Large-Screen Displays Attract Attention

The 103-inch display dominates the scene even when it's installed in a very large space. Large-screen displays appeal strongly to viewers with their vibrant, high-density information, even in areas crowded with people. Their wide viewing angle also ensures that the powerful images are clear and sharp when viewed from virtually anywhere, to allow the high-impact screens to be easily enjoyed by everyone.



Simultaneous Display of Several Information Streams on Large, High-Resolution Screens

Because multiple types of information can be displayed simultaneously on these high-visibility, large-screen models, there is no more problem of information being blocked by multi-screen frames. Several information streams, such as live broadcast images and sports results, can be shown on the clear and easy-to-see display.

103-inch (85-inch) Multi-View Function

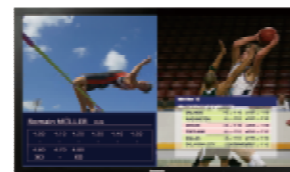

Multi-Screen System



There are no frames to block the information, so the information images are easier to see.



The displays needed to be large enough to present the kind of impact and viewing comfort people have come to expect, whether sitting in the front, center or back of the room.

Installation Examples

【High Moving Picture Resolution】

A full 1,080 lines of moving picture resolution clearly shows fast-action scenes, such as sports events, and scrolling subtitles.



300 Lines of Moving Picture Resolution



1,080 Lines of Moving Picture Resolution

【Durability】

Impact-resistant hard glass protects the front of the plasma display to prevent cracking in the event of an external impact. This increases the level of customer safety.



The front panel resists intentional scratching, and can be easily maintained by simply wiping off soiling and dust with light swipes of a soft cloth.

【Flexible Installation】

The wall-mounting installation provides a neat and clean appearance, and the display can also be suspended from the ceiling.

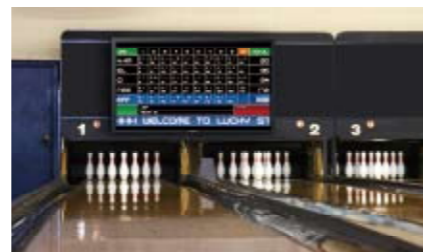

*When installing more than one display on a wall, the wall strength must be confirmed by a qualified technician.



Sam's Town Las Vegas, USA

Live broadcasts of college and professional sports and racing events fill the large screens inside this casino. High-quality, full-HD images allow the odds and results of races to be clearly viewed.

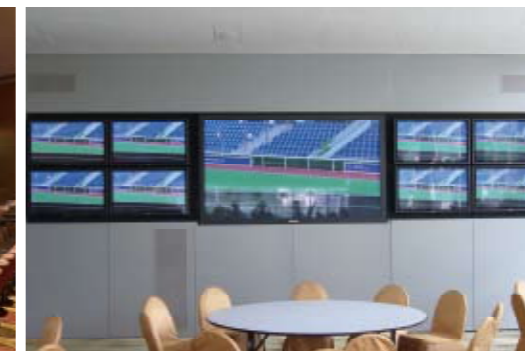

Hong Kong Jockey Club Hong Kong, China

Plasma displays have been installed in the clubhouse of the Hong Kong Jockey Club. Staffs praise the durability of the displays and the fact that their excellent image quality clearly displays the fast motions of the horses without any afterimages.



West Ashfield Leagues Club Australia

Several 103-inch plasma displays are installed at the spectator seats, game floor, and restaurant of the West Ashfield Leagues Club. Panasonic plasma displays can be individually configured and mounted either horizontally or vertically, they were ideally suited to meet the Club's special needs.

Rentals/Exhibitions

The Impact of the Large Screen Pulls in Crowds

Providing visitors with accurate information is an essential task for every exhibition. Even in spaces where many people gather, these large-screen plasma displays enable highly persuasive presentations with their wide viewing angle and high-resolution images. And they also attract and captivate visitors with their impressive size and attractive, eye-catching effects.

Large-Screen Displays Are Highly Visible

These bright displays leave a strong impression even when viewed from an adjacent walkway. They also provide visitors with comfortable viewing at virtually any angle. Their sharp, crisp images, even under bright lighting, help to enhance presentation effects. And because they are self-illuminating, the shadow of the presenter never blocks the screen, allowing accurate information to be clearly conveyed even in a crowded booth.



Flexible Installation

A variety of installation methods are available to match your booth. If ceiling suspension is not possible, the display can be mounted to the wall. The 85-inch model can also be installed on the floor by using the optional floor stand. Both models can be installed vertically, depending on the images being displayed. It is easy to come up with installation plans that use the available space most effectively.



This makes it possible to conduct appealing promotions, such as showing car models or announcing new products that could not ordinarily be shown due to limited space.

【Wide Viewing Angle】

The wide viewing angle enables the same information to be shared from any angle. This lets you clearly convey the points in your presentation to a large number of visitors.



【Lifelike Colour Reproduction】





Even when an actual product cannot be shown at the booth, these large-screen displays will display lifelike images of the product in its actual size and colour.



【Weekly Command Timer】

By setting the display order and schedule, you can show the content in a planned sequence without having to assign a staff member for operation, or management.

■ A Weekly Command Timer Example

-  8:00-11:00
Show video images.
-  11:00-17:00
Show images from a DVD player connected with an HDMI cable.
-  17:00-19:00
Show PC images.
• Use as a screensaver.
-  19:00-23:00
Show PC images.
• Use as a screensaver (with inverted colours).

Installation Examples



Himeji Tourist Information Centre Hyogo, Japan

Himeji is a popular city for sightseers because it contains a number of World Heritage Sites. Plasma displays were installed at the city's information centre. Sharp, clear images convey the attractions of the region to a large number of tourists each day.

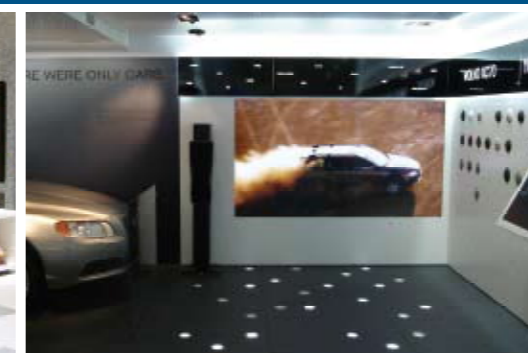

Volvo Car Corporation Sweden

A 103-inch plasma display has been embedded into this wall to conserve showroom space. Its bright, high-resolution images promote current and upcoming models.

Home Cinema

Large-Screen Movies — Entertainment at Its Best

Full-HD plasma displays are ideal for reproducing movies and sports programmes. Their high moving picture resolution clearly shows fast motion, and their excellent colour reproduction renders hues that are remarkably faithful to the original. These large-screen models make it possible to configure a theatre system that has the image power to pull viewers right into the scene.

Stunning Large-Screen Images

Images are reproduced with superb gradation, from dazzling whites to robust blacks, and exceptional moving picture resolution. Action movies and sports broadcasts can be displayed clearly, with no afterimages on the powerful large screens.

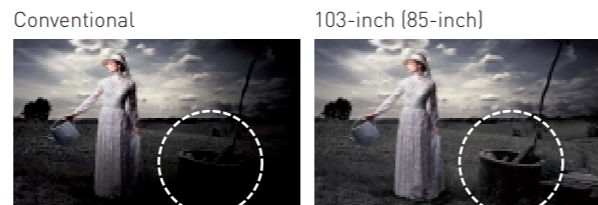

Even the dark parts of movies are faithfully reproduced, without blocked shadows.

Colours Are Faithful to the Original

A level of colour expression that exceeds even the colour gamut of the HDTV standard* renders the highly unique hues that are intended by filmmakers, to faithfully reproduce the colouring particular to each image. In addition to movies, the images in TV programmes are also produced with remarkably beautiful colours.

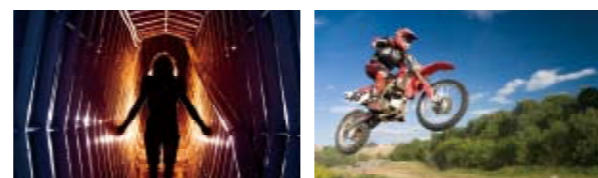

The wide colour range displays beautiful images in all types of content.

* Standard name: ITU-R BT.709.

[Customised Viewing]

You can create, name, and store 8 different combinations of user adjustments from the menu. You can then easily switch to the preferred setting for viewing movies, sports, or playing video games.

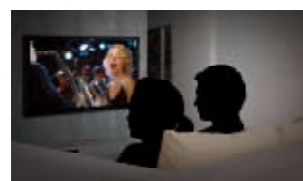

Watching movies
Watch movies in a darkened, theatre-like atmosphere.



Playing games
Crisp, vivid colours make games even more exciting.



Watching sports
Show fast-moving athletes in vibrant colours.

[Customisable Design]

Function slots let you connect the display to a wide range of devices, and make it easy to configure a theatre system. Connected devices can also be changed by simply exchanging the boards in the slots.

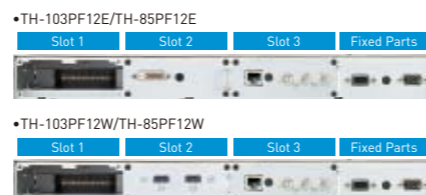

*For details of the optional function board, please visit our Professional Plasma Display site (panasonic.net/proplasma).

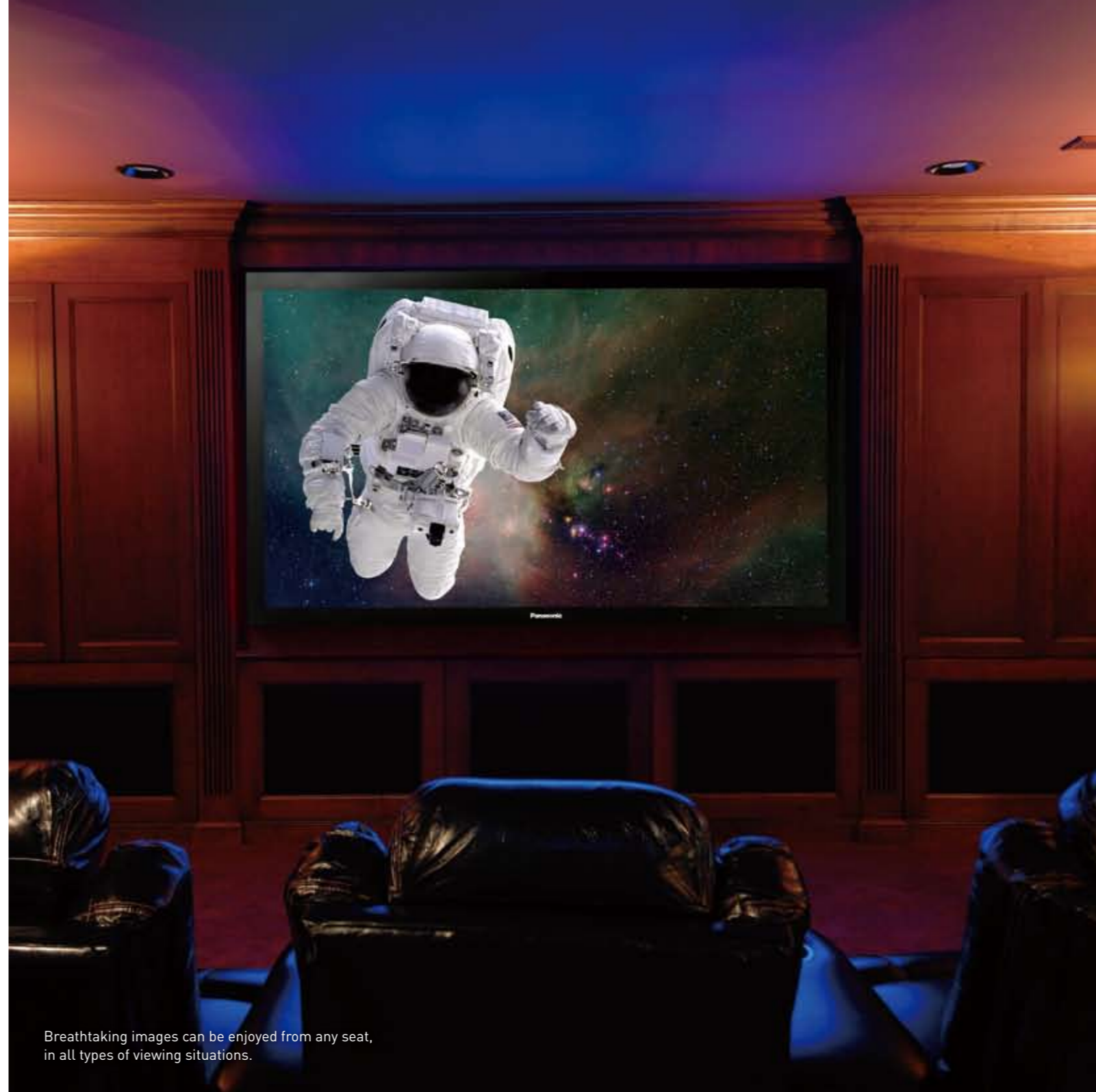

Breathtaking images can be enjoyed from any seat, in all types of viewing situations.



When mounted on a wall, the back of the display requires only 500 mm of space. This ensures that the display doesn't take up excessive space.

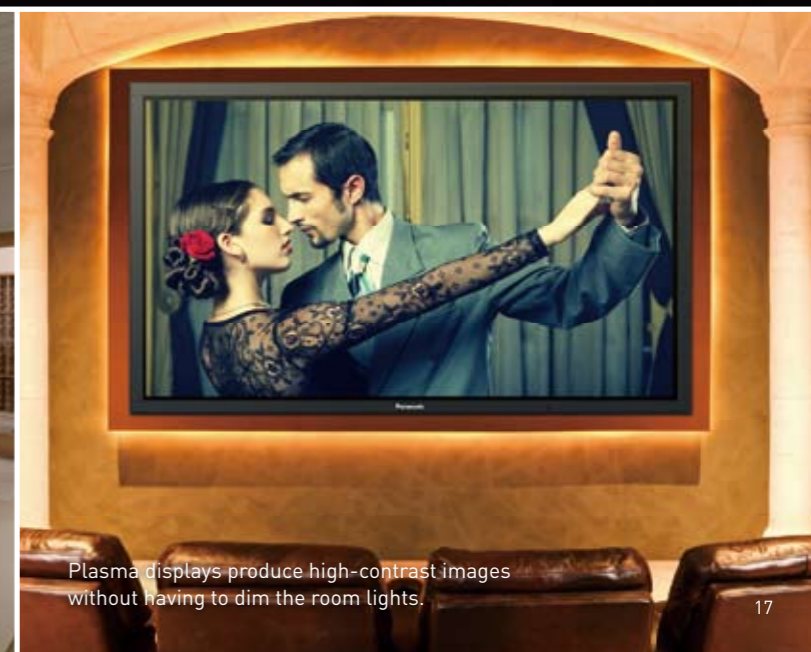

Plasma displays produce high-contrast images without having to dim the room lights.

Professional Plasma Displays Meet a Wide Range of Needs — From Stores to Open Spaces

Large-Screen, High-Resolution Displays Grab Attention and Convey Accurate Information

Digital Signage

Tokyo Broadcasting System Television, Inc.

Tokyo, Japan

This information transmission system with a 103-inch plasma display at its core was installed at an event space facing a subway station in Akasaka, Tokyo. Its highly reliable display of beautiful full-HD images has made it very popular.



Callaway Golf Company

Tokyo, Japan

The 103-inch plasma display transmits messages from the world's leading manufacturer of golf clubs, backed by beautiful images that reflect the company's brand image. High-resolution images with rich gradation are clearly displayed even in bright room lighting.



Amusement

Midland Square Cinema

Aichi, Japan

The 103-inch display, whose rich gradation, deep black expression, and high moving picture resolution make it ideal for reproducing movies, has been installed in the lobby of this cinema. Even under natural sunlight, it displays clear images to provide customers with movie previews and other information.



Range of Needs —

Public Facilities

National Astronomical Observatory of Japan

Tokyo, Japan

This display supports Japan's world-leading research into solar physics by clearly reproducing measurement data that was recorded using precision equipment on Hinode, a solar observation satellite. The wide viewing angle and dynamic power of the 103-inch display also boost the effect of the facility's press releases.

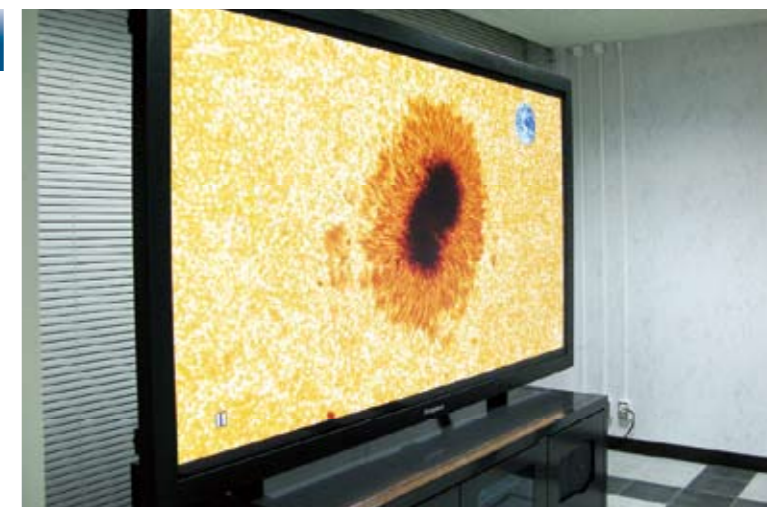

Hyogo Prefecture Disaster Management Centre

Hyogo, Japan

Several 103-inch displays were installed at the core of the Centre's disaster response information network. The displays serve to collect information from various regions during emergencies together with weather monitoring data, to support meetings for planning countermeasures.



Education

National Training Centre

Tokyo, Japan

A 103-inch plasma display and HD camera were installed here, where Japan's top athletes train. The plasma display's high moving picture resolution clearly shows athlete movements, to maximise the effectiveness of training methods.





TH-103PF12 (Anti-Glare, Low-Reflection model)
103-inch (260 cm) diagonal
Full High Definition Plasma Display

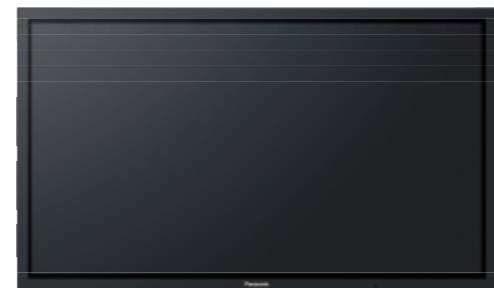

TH-85PF12 (Anti-Glare, Low-Reflection model)
85-inch (217 cm) diagonal
Full High Definition Plasma Display



NeoPDP Technology Doubles*¹ Luminous Efficiency

By developing new panel materials and redesigning structures, circuits and drive technology, NeoPDP technology was able to double*¹ the luminous efficiency over previous models. This also led to improvements in brightness, contrast and motion image performance.

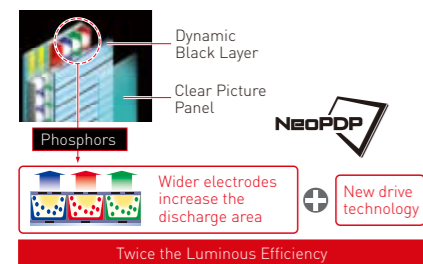

*1 Comparing full-HD models in existing sizes with same-size 2007 Panasonic models.

40,000:1 Contrast Produces Rich, Robust Blacks

The world's highest level*² of contrast, a ratio of 40,000:1*³ (with dynamic contrast of 2,000,000:1*⁴) was achieved with image processing technologies like Panasonic's original Dynamic Black Layer. Rich blacks create a sense of depth that draws viewers right into the scene.

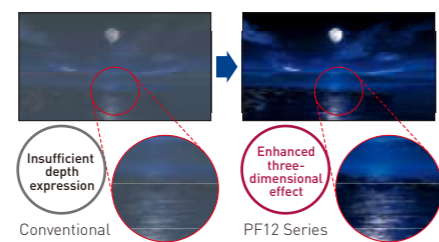

*2: For professional plasma displays, as of June 17, 2009 (according to a Panasonic survey).
*3: Dark-area contrast that can be displayed simultaneously on the same screen.
*4: The ratio of brightness of a screen displaying an all-white signal to the brightness of a screen displaying an all-black signal.

Industry's Highest Level*² of Gradation — 6,144 Equivalent Steps

The industry's highest level*² of gradation — 6,144 equivalent steps — has been achieved for virtually all kinds of scenes. Rich gradation extends from dazzling whites to robust blacks to render even finely detailed textures.

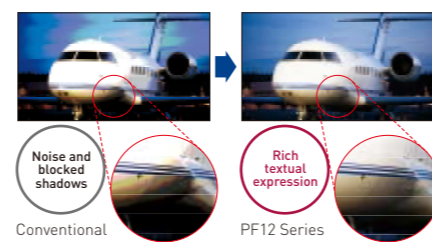

1,080 Lines of Moving Picture Resolution Clearly Show Fast-Moving Images

The high moving picture resolution of the plasma display clearly and accurately reproduces even fast-moving images while suppressing afterimages. The finest details are beautifully displayed with the superb resolution of full-HD.

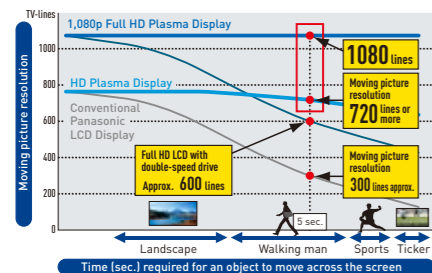

* Moving picture resolution is a quantitative measurement of detail in displayed motion pictures discernible by the human eye. Using a measurement method developed and applied by the APDC (Advanced PDP Development Centre Corporation).

Exceeding the Colour Gamut of the Full-HD (HDTV) Standard

Hi-definition broadcasts are based on the HDTV standard*⁶, rather than the conventional NTSC standard. Panasonic plasma displays reproduce a wide colour gamut exceeding the entire colour range specified in the HDTV standard (ITU-R, BT.709)*⁷. This provides large-screen displays with natural colours that are faithful to the original images. Highly intricate images are also reproduced by using Digital Colour Reality technology to digitally control video signals with a high degree of accuracy.

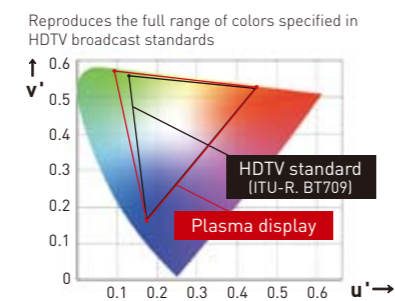

*6: Standard name: ITU-R BT.709.
*7: Comparison based on colour gamut

Robust Displays for Installation in Public Spaces

Tempered glass protects the front surface of these plasma displays. In the case of an external impact, this durable design will help to prevent cracking and other damage. The displays can be installed and operated in public spaces where a large number of people pass through, such as hallways and lobbies, without requiring a special protective layer.

Function Slots for Versatile Application

Three function slots allow the display's connection terminals to be easily exchanged. Simply select the function boards that are required for your image sources, and combine them accordingly.

*For details of the optional function board, please visit our Professional Plasma Display site (panasonic.net/proplasma).

Specifications

		TH-103PF12	TH-85PF12		
DISPLAY	Screen Size (Diagonal)	103-inch	85-inch		
	Aspect Ratio	16:9	16:9		
	Effective Display Area (W x H)	2,269 x 1,276 mm	1,889 x 1,062 mm		
	Number of Pixels (H x V)	1,920 x 1,080 pixels	1,920 x 1,080 pixels		
	Pixel Pitch (H x V)	1.182 x 1.182 mm	0.984 x 0.984 mm		
	Contrast Ratio	40,000:1	40,000:1		
	Gradation	6,144 steps (equivalent)	6,144 steps (equivalent)		
SIGNAL COMPATIBILITY	Scanning Frequency	Horizontal : 15 — 110 kHz / Vertical : 48 — 120 Hz			
	PC Signal Compatibility	VGA, SVGA, XGA, WXGA, SXGA, UXGA (Over SXGA resolution: compressed)			
INPUT	Video Signal Compatibility	525 (480i/60i, 60p); 625 (575i/50i, 50p); 625 (576i/50p); 750 (720i/60p, 50p); 1125 (1080i/60i, 50i, 24p, 24sF, 25p, 30p, 60p, 50p); 1250 (1080i/50i)			
	COMPONENT IN	BNC x 3 (on Function Board)			
	AUDIO IN (for COMPONENT)	M3 x 1 (on Function Board)			
	DVI-D IN	DVI x 1 (E model)			
	HDMI IN	Type A connector x 2 (on Function Board)			
	PC IN	Mini D-sub 15-pin x 1			
	AUDIO IN (for PC)	M3 x 1			
CONTROL	RS-232C	D-sub 9-pin x 1			
	LAN	RJ45 10BASE-T/100BASE-TX, compatible with PLink™			
SOUND	Audio Output	RCA (L/R) x 1 set, Output level: variable (-∞ to 0 dB at 10 kΩ)			
	Power Requirements	200-240 V AC, 50 Hz/60 Hz (E model)	200-220 V AC, 50 Hz/60 Hz (W model)	220-240 V AC, 50 Hz/60 Hz (E model)	200-220 V AC, 50 Hz/60 Hz (W model)
ELECTRICAL	Power Consumption	1,450 W (E model)	1,400 W (W model)	1,100 W (E model)	1,200 W (W model)
	On Mode Average Power Consumption*	1,065 W		890 W	
	Power off Condition	0.4W		0.4W	
	Stand-by Condition	Save OFF : 1.2 W, Save ON : 0.7 W			
	MECHANICAL	Dimensions (W x H x D)	2,412 x 1,419 x 129* ¹ mm		2,015 x 1,195 x 99 mm
OPERATION	Weight (approx.)	201 kg		117 kg	
	Function Slot (Vacant)	3 [1]			
MECHANICAL	Temperature/Humidity	0 °C to 40 °C/20 % to 80 % (Non condensation)			
	Altitude	0 to 2,400 m			
	Radiation Regulations	EN55022 Class-B, EN55024 EN61000-3-2, EN61000-3-3 (E model) CISPR22 Class-B, GOST CE, FCC Part 15 Class-B, ICES-003, NOM approval (W model)		EN60065 Ver.7 (E model) CIAPR22 Class-B, GOST CE, FCC Part 15 Class-B, ICES-003, NOM approval (W model)	
	Safety Standards	EN60065 Ver.7 (E model) AS/NZS60065, SASO, IEC60065, SS (Singapore), GOST12.2.006-87, UL6500 Ver.2, NOM approval (W model)		EN55022 Class-B, EN55024 EN61000-3-2, EN61000-3-3 (E model) AS/NZS60065, SASO, IEC60065, SS (Singapore), GOST12.2.006-87, IEC60065, UL6500 Ver.2, NOM approval (W model)	

* Based on IEC 62087 Ed.2 measurement method. *1: Exclusive of protruding portion (141 mm when including the protruding portion of the slot)

Dimensions

TH-103PF12

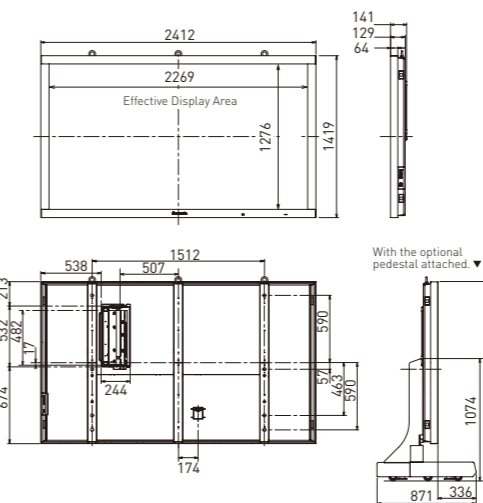

TH-85PF12

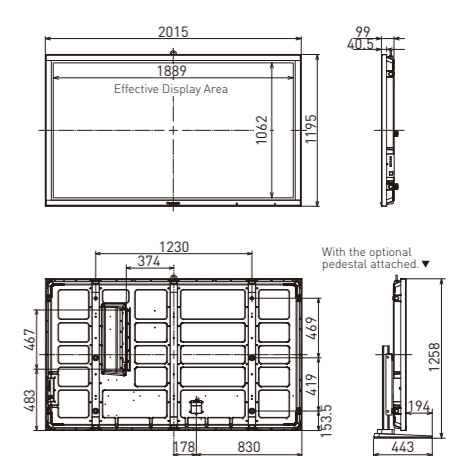

Options

Pedestal

TY-ST103PF9
Weight: 122.0 kg

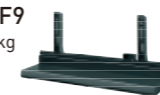

TY-ST85P12
Weight: 58.0 kg



Wall-hanging bracket

TY-WK103PV9
Weight: 25.0 kg



TY-WK85PV12
Weight: 18.0 kg



Ceiling-hanging bracket

TY-CE103PS10
Adjustable angle: 0° — 20°
Weight: Vertical type: 15.0 kg
Inclined type: 37.0 kg



TY-CE85PS12
Adjustable angle: 0° — 20°
Weight: 35.0 kg



Floor stand

TY-ST85PF12
Weight: 82.0 kg

* To prevent overturning when using the floor stand, mount the stand brace to the wall. This will halt any vibration. The casters are not to be used for moving the main unit around.

